

We are IntechOpen, the world's leading publisher of Open Access books Built by scientists, for scientists

4,100

Open access books available

116,000

International authors and editors

120M

Downloads

Our authors are among the

154

Countries delivered to

TOP 1%

most cited scientists

12.2%

Contributors from top 500 universities



WEB OF SCIENCE™

Selection of our books indexed in the Book Citation Index
in Web of Science™ Core Collection (BKCI)

Interested in publishing with us?
Contact book.department@intechopen.com

Numbers displayed above are based on latest data collected.
For more information visit www.intechopen.com



Study for Wind Generation and CO₂ Emission Reduction Applied to Street Lighting – Zacatecas, México

Francisco Bañuelos-Ruedas,
César Ángeles-Camacho,
Guillermo Romo-Guzmán and
Manuel Reta-Hernández

Additional information is available at the end of the chapter

<http://dx.doi.org/10.5772/54019>

1. Introduction

The widespread concern in developed and developing countries to generate clean and sustainable energy, has led to search for alternative sources for non polluting power generation such as wind power. Although electric power generating costs by harnessing the wind resource are still higher than production with conventional plants, the difference is being reduced, depending on the system capacity. Integrating wind power systems to distributed generation scheme, the efficiency of transmission and distribution may increase.

An specific application of wind generation is to provide electric energy for street lighting in cities or towns close to wind farms. In Mexico, the cost of wind power electricity may satisfy the demand in public lighting with acceptable cost per kWh.

Since ancient times, the wind has been used for various purposes, including navigation, grain mills and irrigation. It was until the early twentieth century when wind power started his application in electric generation. It was more expensive, though, to produce electricity from wind power than with conventional fossil fuels plants. In recent decades, the technology development to harness the wind resource has accelerated, and today many countries use the wind resource on a large scale at competitive costs. It started with small generators using a few watts of power, and currently there are up to 5 MW wind turbine generators with possible capacity of 7, 10 and 20 MW for the coming years [1]. Figure 1 shows the growth of wind turbines related to their installation heights.

This chapter provides a study concerning an estimation of wind resources and the possibility of supplying electricity for street lighting from wind farms in the state of Zacatecas, Mexico. It also presents a summary of environmental impact concerning the tons of CO₂ not released to the environment using this type of generation.

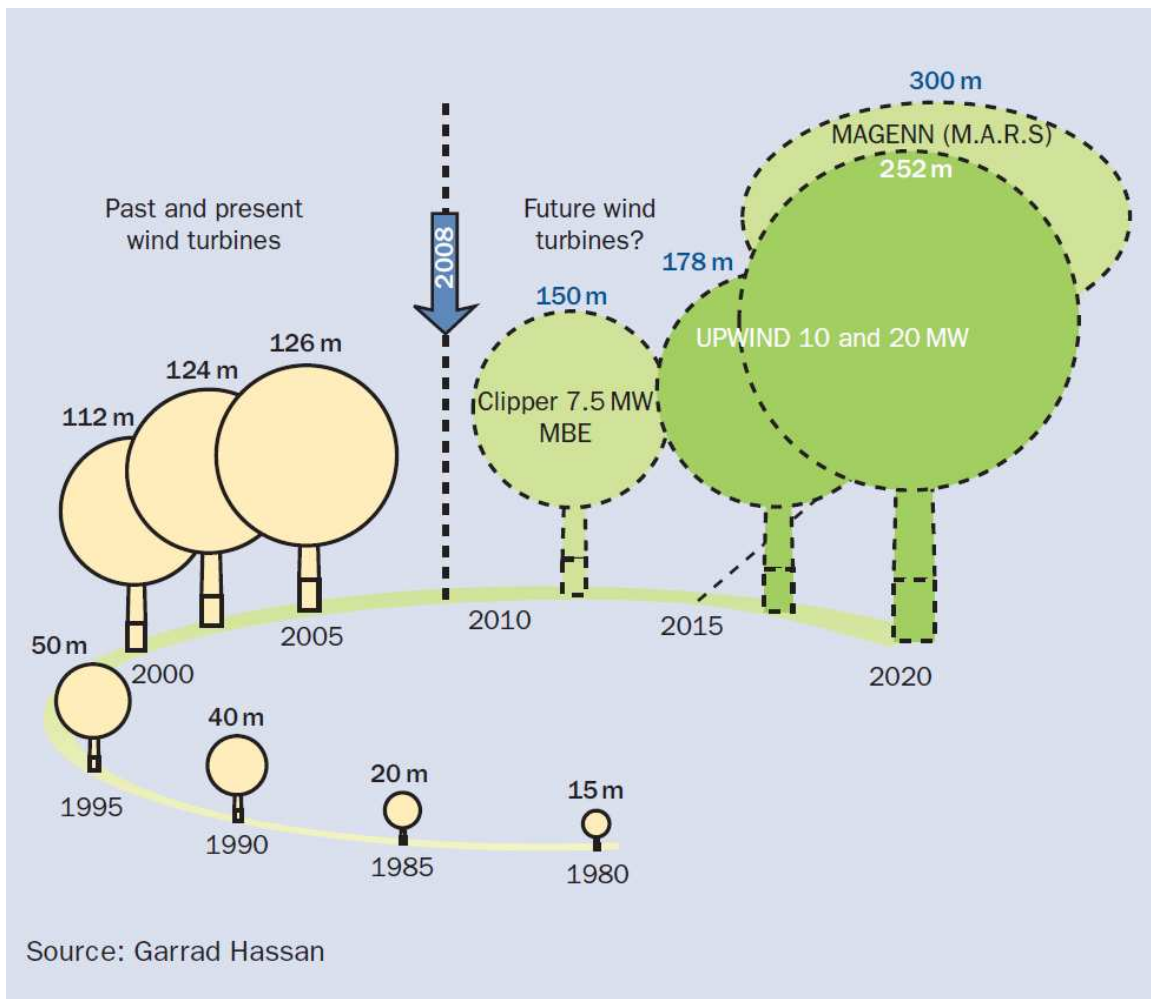
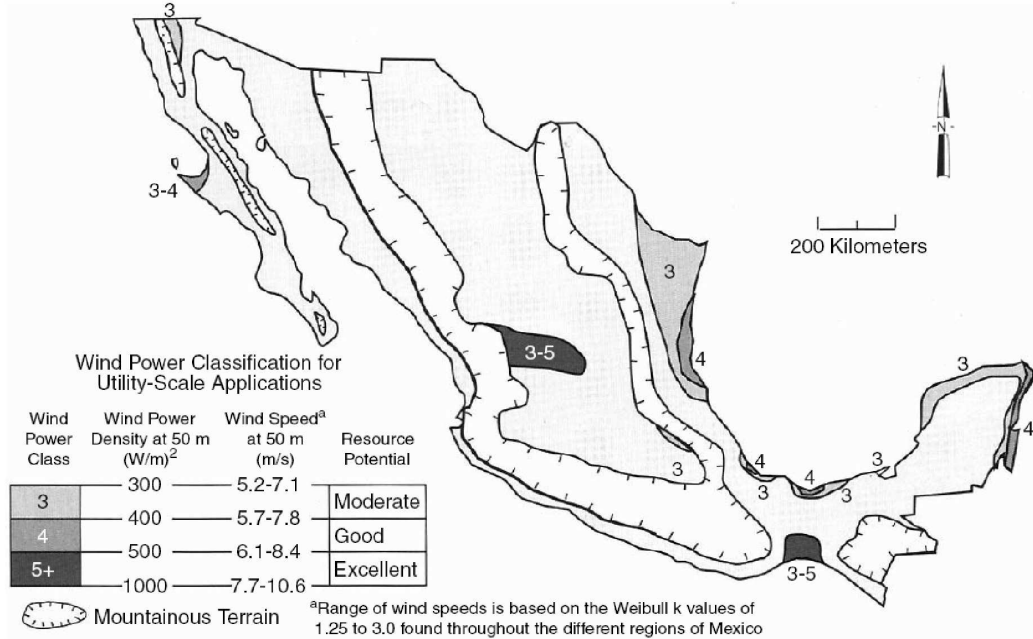

Figure 1. Growth in size of commercial wind turbine designs [1]

2. Wind resource in Mexico

According to a wind resource evaluation performed in 1995 by Schwartz and Elliott [2], México has interesting regions with wind capacity to produce electric energy. Figure 2 a) shows estimated utility-scale areas in Oaxaca (Istmo de Tehuantepec), Veracruz, Tamaulipas, Yucatan, Quintana Roo, Baja California and Zacatecas, with wind power classes from 3 to 5. Figure 2 b) shows wind capacity for rural-scale areas for the rest of the country with wind power classes from 1 to 4.

Mexico—Preliminary Wind Resource Map for Utility-Scale Applications



(a)

Mexico—Preliminary Wind Resource Map for Utility-Scale Applications

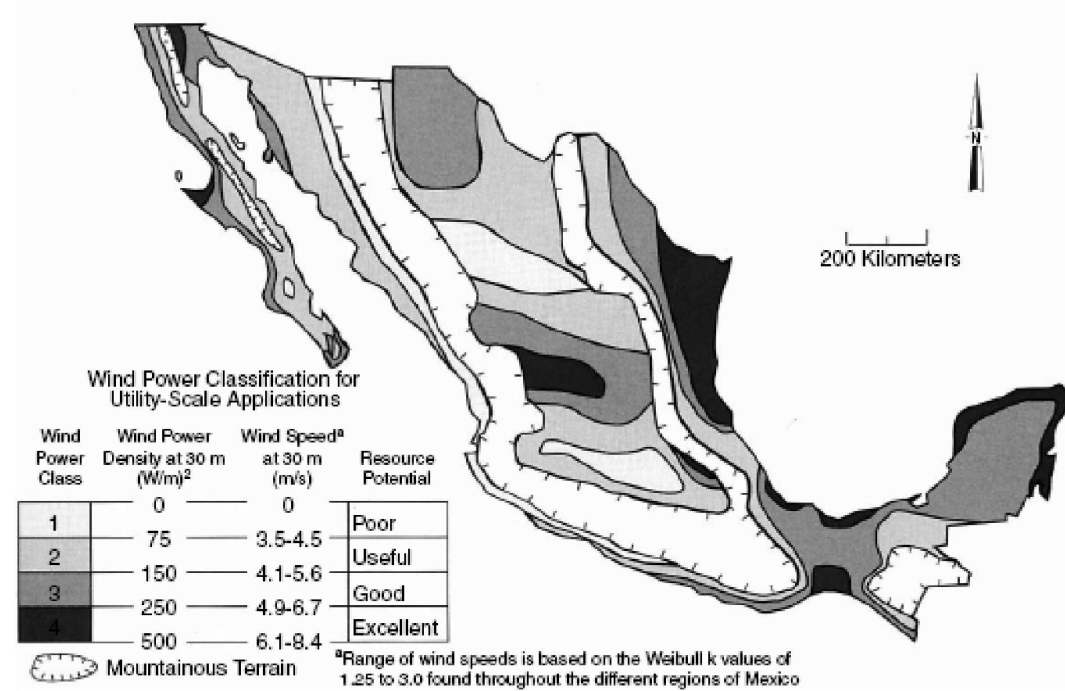

(b)

Figure 2. Preliminary wind resource of Mexico estimated by Schwartz and Elliott [2], a) for utility-scale applications; b) for rural-scale applications.

In 2007, Klapp, Cervantes-Cota and Chavez [3] published estimated wind power data for Mexico, showing potential wind power capacity in MW (Figure 3). Some of the more studied areas shown are Zacatecas (400 MW), Oaxaca and Chiapas (2000 MW), and Baja California (100 MW). Some of the less studied areas are Tamaulipas (700 MW), Veracruz, Hidalgo and Puebla (600 MW), Baja California Sur (50 MW), Quintana Roo and Yucatán (800 MW), Chihuahua (50 MW), and Sinaloa (100 MW). The estimated capacity factors go from 18 % to 30%, and 50% in Oaxaca (Istmo de Tehuantepec).

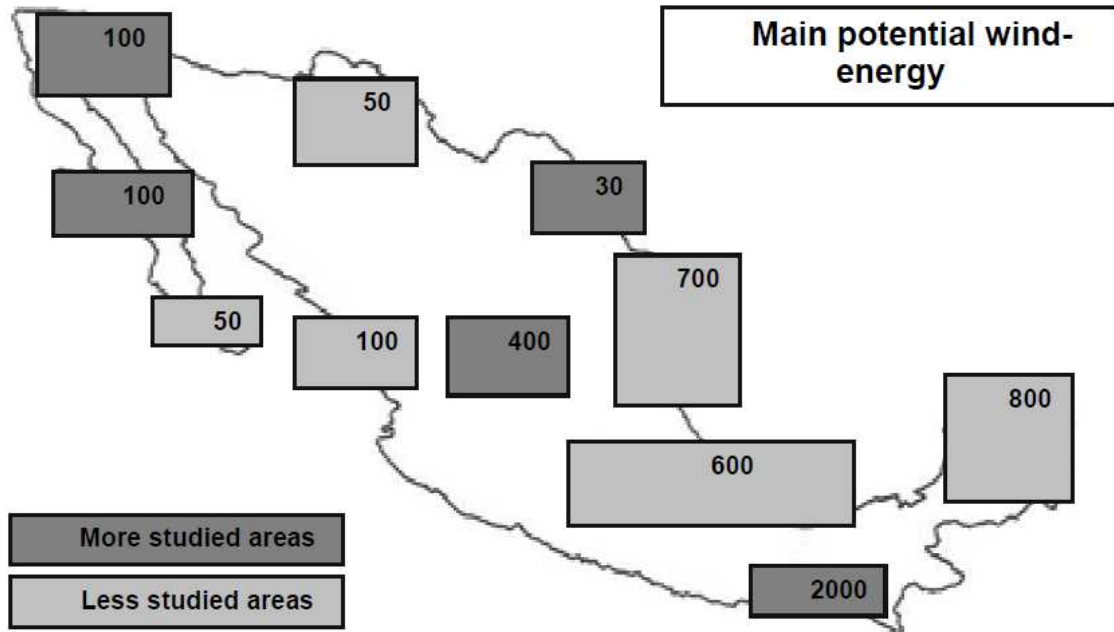

Figure 3. Estimated wind potential areas in Mexico, in MW, shown by Klapp, Cervantes-Cota and Chavez [3]

The wind power prospective in Mexico 2011-2025 reported by SENER [4]-[5], estimates a wind resource of 71,000 MW considering capacity factors between 20% and 30% (Table 1). For capacity factors between 30% and 35% the estimated wind potential is around 11,000 MW. For capacity factors beyond 35%, the estimated wind potential is 5,235 MW.

Capacity factor (%)	Land (%)	Estimated Wind Capacity (MW)
20-25	56.7	40,268.0
25-30	27.5	19,535.0
30-35	8.4	5,961.0
35-40	3.5	2,500.0
> 40	3.9	2,735.0
<i>Total</i>	100	71,000

Table 1. Estimated wind energy potential in Mexico, by SENER [4,5]

3. Wind power plants in Mexico

The significant wind power plants installed in Mexico have been developed during the last seven years. Almost all plants have been installed in Oaxaca, due to its high wind potential, although other regions are being considered. Some other areas are currently being monitored for possible wind exploitation. Table 2 shows the wind power projects developed until 2010, according to SENER [5] and AMDEE [6].

At the end of 2011, the wind capacity installed in Mexico reached 873 MW (position 19 in the global ranking, according to GWEC [7]). There are some other projects in planning stage to be constructed during the next three years, expecting a total capacity of 6,792.7 MW at the end of 2014 [6].

Project	Location	Developer	Date of commercial operation	Capacity (MW)
La Venta	Oaxaca	CFE	1994	1.6
La Venta II	Oaxaca	CFE	2006	83.3
Parques Ecológicos de México	Oaxaca	Iberdrola	2009	79.9
Eurus, phase 1	Oaxaca	Cemex/Acciona	2009	37.5
Eurus, phase 2	Oaxaca	Cemex/Acciona	2010	212.5
Gobierno Baja California	Baja California	GBC/Turbo Power Services	2010	10
Bii Nee Stipa I	Oaxaca	Cisa-Gamesa	2010	26.35
La Mata - La Ventosa	Oaxaca	Eléctrica del Valle de México (EDF-EN)	2010	67.5
<i>Total</i>				518.63

Table 2. Wind power plants in operation in Mexico at the end of 2010 [5,6]

The Energy Department, SENER [4], expects a continuous and sustained growing in all renewable energy sectors for electric energy production, predicting a total wind capacity of 11,703 MW at the end of 2024. Table 3 shows the distribution of expected electricity production with all types of renewable resources. It can be observed that wind power capacity will be the second resource (39.6%), only after hydroelectric power. The total predicted value is 31,854 MW.

Resource	MW	%
Hydroelectric < 30 MW	1,348	4.2
Hydroelectric > 30 MW	14,657	46.2
Solar PV (Photovoltaic)	1,942	6.1
Solar CSP (Concentrated Solar Power)	69	0.2
Bioenergy	905	2.9
Geothermal power	1,230	3.6
Wind power	11,703	39.6
<i>Total</i>	31,854	100.0

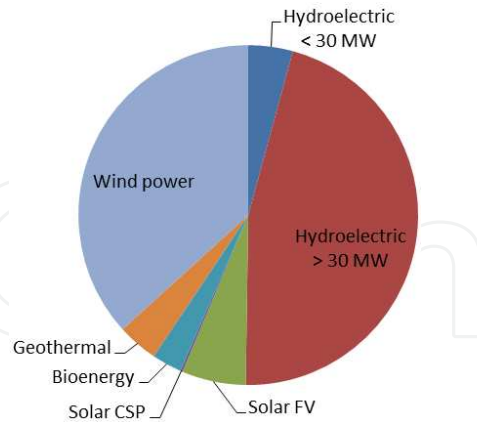

Table 3. Predicted values of electricity production from renewable energy resources in Mexico in 2024 [4]

4. Wind resource estimation

The construction feasibility of any wind project requires the fulfillment of several points, such as:

- a. Selection of site.
- b. Wind speed and wind direction monitoring.
- c. Wind rose description.
- d. Electric network close to the site.
- e. Environmental studies.
- f. Economical / social studies.
- g. Geographical access.
- h. Legal permits.
- i. Wind turbine/generator electro-mechanical modeling.
- j. Technical /economical analysis of the wind plant.

The impact of wind generation projects must be evaluated by two fundamental factors: environmental issues and power electric grid characteristics.

In the first case, it can be outlined the following impacts [8]:

- Atmosphere.
- Effects on flora.
- Effects on birds.

- Visual.
- Noise.

The impact of wind power generation on the power electric grid may be measured on short, middle and large periods of time, taking into account factors as:

- Level of penetration.
- Capacity of electric grid.
- Structure of power generation.

The level of possible penetration can be determined by (a), (b) y (c) described above in the wind resource estimation.

The wind resource estimation of the site requires monitoring of several climate variables as wind speed, wind direction, temperature and atmospheric pressure taken, at certain hight, every two minutes during, at least, twelve consecutive months. All data obtained is statistically processed through specialized computational tools to obtained plots and characteristics curves [9]-[10] like wind rose wind speed–frequency distribution curve. The wind resource of a region (wind map) is obtained later, considering the data of several sites.

Figures 4 and 5 show the wind rose and wind speed-frequency distribution curve obtained in a monitoring station [11]-[12].

Figure 6 shows the wind maps of a region, indicating a) annual average values of wind speed and, b) annual average values of wind power density.

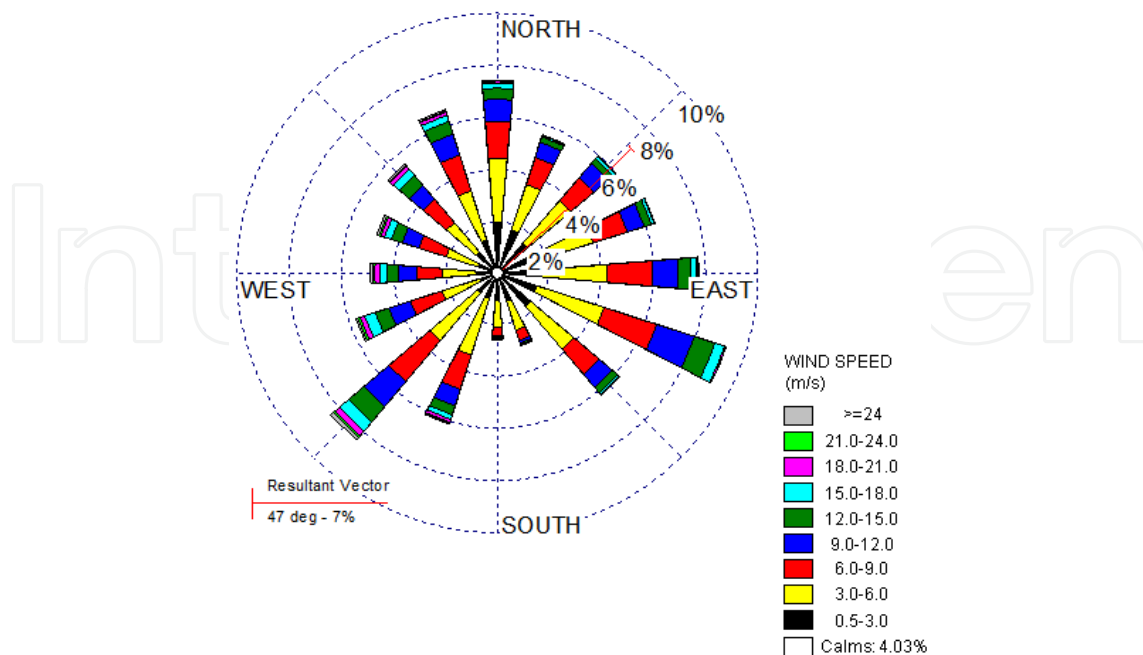

Figure 4. Wind rose obtained in a selected site. Zacatecas, Mexico

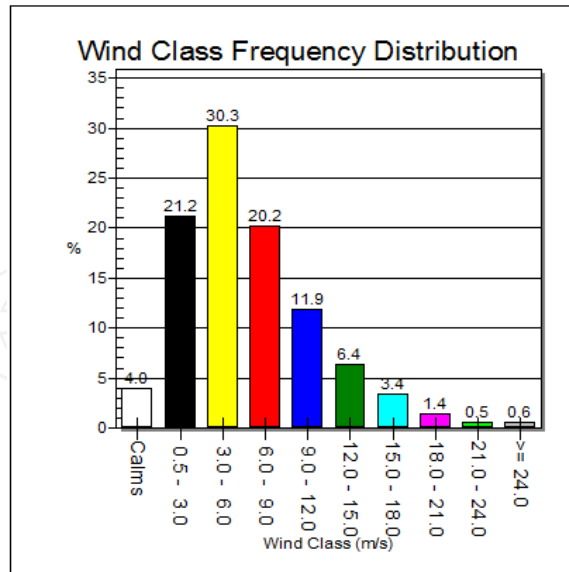

Figure 5. Wind speed-Frequency distribución curve obtained in a selected site. Zacatecas, Mexico

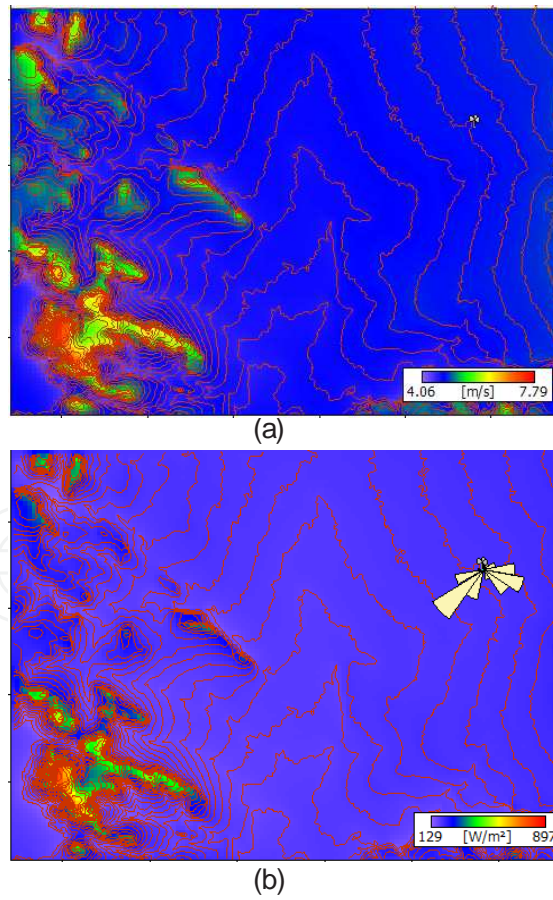

Figure 6. Wind map of a selected region in Zacatecas, Mexico, obtained with WASP® software, showing (a) annual average wind speed, in m/s, and (b) annual average power density, in W/m².

With the wind maps and their corresponding wind roses, the next step to calculate the wind plant is to select the specific area within the studied region that fulfill the environmental requirements.

A wind power plant or wind farm, usually have several wind turbines distributed in the selected area in such a way the available wind resource can be well exploited. The proper turbines arrangement is obtained, generally, by using computational tools and digital simulators, all in compliance with existing national and international regulations.

The electricity produced by the wind turbines in large power plants is fed to power systems through electric transformers and power electronic controllers [13]-[14]. Once the electric energy is sent to the network, it can be applied to different electric loads. Figure 7 shows a general scheme diagram of electricity production and consumption using wind power.

The present document proposes to apply the electric energy produced by the wind turbines in public street lighting or in municipal water pumping. Both loads have high tariff rates in Zacatecas.

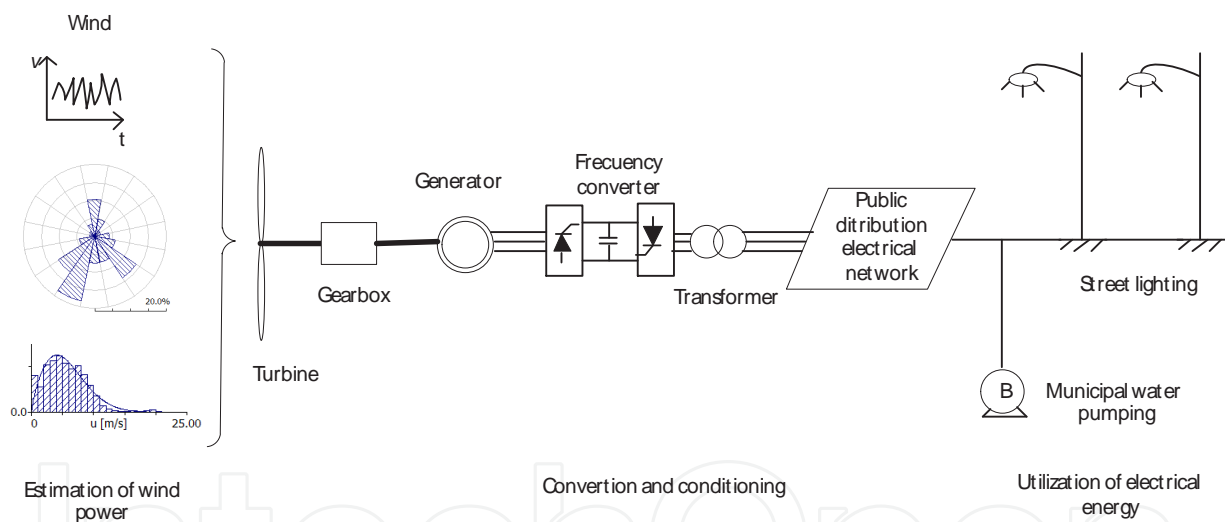

Figure 7. General scheme of electricity production and consumption using wind power.

5. Electric energy demand in Mexico and Zacatecas state

Mexico had during 2011 a total consumption of 186,638,847 MWh of electric energy, with 4.13% consumed in the public sector (7,706,706 MWh). From the total energy demanded by the public sector, 61.55% was consumed in street lighting and 38.44% of was consumed in water pumping. Table 4 shows the electric energy values demanded by the whole country and by Zacatecas state.

Sector	National		Zacatecas state	
	MWh	%	MWh	%
Residential	48,700,399	26.09%	480,403	18.72%
Commercial	12,991,134	6.96%	121,654	4.74%
Agriculture	8,599,593	4.61%	503,559	19.63%
Mid-size industry	70,024,362	37.52%	304,389	11.86%
Large-size industry	38,616,680	20.69%	937,553	36.54%
Public services	7,706,706	4.13%	218,234	8.51%
Total	186,638,874	100.00%	2,565,792	100.00%
<i>Public services</i>				
Municipal water pumping	2,962,516	1.59 %	113,460	4.42%
Street Lighting	4,744,190	2.54%	104,774	4.08%
Total	7,706,706	4.13%	218,234	8.51%

Table 4. Electric energy consumption during 2011 in Mexico and in Zacatecas state [15]

During 2008 the total electric energy consumption in Zacatecas state was 1,726,935 MWh. During 2011, the total consumption increased to 2,565,792 MWh. There have been increases in consumption tariffs for public lighting services and municipal water pumping in the state. Table 5 shows the sales reported by electric utility in Zacatecas state in public sector.

Sector	No of customers	Energy sold (MWh)	Energy sold (%)	Average price (\$ pesos / kWh)	Thousands of pesos
Municipal water pumping (Tariff 6)	1,369	113,460	4.42	1.40	162,901
Street Lighting (Tariff 5A)	10,078	104,774	4.08	2.10	220,253

Table 5. Sales reported by electric utility in Zacatecas state during 2011 [15].

6. Case study-wind electric energy production for public street lighting

6.1. Capacity of wind power plant determination

According to electricity utility, CFE, energy sales for public street lighting in Zacatecas state during 2011 were 104,774 MWh, representing a continuous operating capacity of 11.96 MW. The total energy sales were 2,565,792 MWh, representing, in average, a continuous generation capacity of 292.89 MW for all services.

The electricity consumption for public lighting in the most important city of Zacatecas state, is in average 1,100 MWh per month, representing approximately a wind power plant generation capacity of 1.52 MW with a capacity factor of 30%. This means a total wind power plant capacity of 5.09 MW. The wind power plant may be build with three sets of wind turbines/generators of 2 MW located in a region near to the mentioned city with the required wind capacity [16,17].

6.2. Economic analysis of wind generation costs

Table 6 shows comparison of electricity generation costs using different technologies [18]. It can be seen that wind power generation is a competitive choice in 2011, compared to diesel and steam (oil) technologies. Certainly, it is not a good choice comparing to the other technologies costs outlined in the table, but if other issues as environmental and healthy problems are taken into account, wind power technology is not a bad selection.

Technology	Year			
	2008	2009	2010	2011
Diesel	7.85	8.27	15.91	16.58
Steam (oil fuel)	1.58	1.50	1.79	2.01
Wind power	0.74	0.69	1.02	1.84
Nuclear	1.12	1.05	1.97	1.26
Dual (Coal and oil)	1.10	0.98	0.90	0.96
Turbo Gas and Combined Cycle	1.38	0.87	0.90	0.94
Geothermal	0.59	0.48	0.47	0.56
Hydroelectric Generation	0.49	0.63	0.44	0.51

Generation cost includes:

- Salaries and employee benefits
- Energy and power purchased
- Maintenance and general services contract
- Maintenance and materials consumption
- Taxes and duties
- Cost of labor obligations
- Depreciation
- Indirects costs
- Development and financial cost.
- Other expenses

Table 6. Electricity generation costs in \$ pesos / kWh, using different technology [18].

6.3. Environmental impact

To estimate the environmental impact let us considered the average per month in the operation of the proposed 6 MW wind power plant capacity mentioned in the previous section, the total power delivered during this period will be 1.2 GWh. If contaminants emission of a coal power plant has a rate of 1,058.2 tons of CO₂/GWh, and a rate of 7.4 tons of CO₂/GWh for wind power plant, thus the operation of the wind power plant represents a reduction of 1260.96 tons of CO₂ per month, and 15,131.52 tons of CO₂ per year. Table 7 presents a comparison of CO₂ emissions in conventional power plants and in a wind farm that supplies 1.2 GWh per month. The emission factors are based on references [19-21].

Source	Capacity in GWh per month	CO ₂ /GWh (Tons)	Total CO ₂ emitted (Tons)
Coal	1.2	1,058.20	1,269.84
Oil	1.2	820	984.00
Natural gas	1.2	524	628.80
Wind energy	1.2	7.4	8.88

Table 7. Comparison of CO₂ emission per month from fossil fuel plants and wind power plant of 1.2 GWh

All electric energy demanded per year for public street lighting in Zacatecas state (104,774 MWh), representing a continuous operation capacity of 11.96 MW, could be supplied by a wind power plant with a total capacity of 40 MW, capacity factor 30%. Table 8 shows the CO₂ emissions produced per year in conventional power plants and in a wind farm that supplies 104.77 GWh per year.

Source	Capacity in GWh per month	CO ₂ /GWh (Tons)	Total CO ₂ emitted (Tons)
Coal	104.774	1,058.20	110,871.85
Oil	104.774	820	85,914.68
Natural gas	104.774	524	54,901.58
Wind energy	104.774	7.4	775.33

Table 8. Comparison of CO₂ emission per year from fossil fuel plants and wind power plant of 104.77 GWh

In Tables 7 and 8 can be observed the big differences in CO₂ emissions by using fossil fuel and wind energy technologies applied to public street lighting in Zacatecas. This is a simple example of the benefits that can be obtained by using wind energy.

7. Conclusions

Monitoring and estimation of wind resource of an specific site are fundamental tasks to start a wind power plant project. They determine if the site has the minimum requirements to exploit the wind resource. Once the wind capacity is evaluated, the next step is to establish the electric energy demand.

In this chapter it is discussed how the electric energy demand for public street lightning and water pumping in the State of Zacatecas, Mexico, could be supplied by wind energy. Nowadays, the electricity produced by wind power plants has reached competitive costs that may be applied in public street lightning, besides the reduction of CO₂ emitted to the atmosphere and its corresponding carbon bonuses. It is concluded that is widely recommended to apply the wind energy production in public street lightning for Zacatecas State, even tough is necessary to complete more extensive environmental and grid impact studies.

Acknowledgments

The authors wish to give their acknowledgments to Universidad Autónoma de Zacatecas (UAZ) and Instituto de Ingeniería, UNAM. F. Bañuelos-Ruedas, G. Romo-Guzmán y M. Reta-Hernandez thank the support to Unidad Académica de Ingeniería Eléctrica, UAZ, and C. Angeles-Camacho thanks the support given by Program for Research and Technology Innovation Project (PAPIIT), through project IN151510, to complete the present chapter.

Author details

Francisco Bañuelos-Ruedas¹, César Ángeles-Camacho², Guillermo Romo-Guzmán¹ and Manuel Reta-Hernández¹

¹ Universidad Autónoma de Zacatecas, México

² Instituto de Ingeniería de la UNAM, México

References

- [1] European Wind Energy Association. EWEA: Wind energy – the facts, Executive summary. [http://www.ewea.org/fileadmin/ewea_documents/documents/publications / WETF/1565_ExSum_ENG.pdf](http://www.ewea.org/fileadmin/ewea_documents/documents/publications/WETF/1565_ExSum_ENG.pdf). (accessed 30 July 2012).
- [2] Schwartz MN and Elliott DL. Mexico wind resource assessment project. DOE/NREL Report No. DE95009202, National Renewable Energy Laboratory, Golden, Colorado, March 1995.

- [3] Klapp J, Cervantes-Cota J and Chávez L J., editors. Towards a cleaner planet. Energy for the future. New York: Springer; 2007.
- [4] Secretaría de Energía. SENER. Prospectiva de energías renovables 2011 – 2025. México: SEDE; 2011.
- [5] Secretaría de Energía. SENER. Prospectiva del sector eléctrico 2011 – 2025. México: SEDE; 2012.
- [6] Asociación Mexicana de Energía Eólica. AMDEE: Proyectos eólicos en México. http://amdee.org/Recursos/Proyectos_en_Mexico. (accessed 3 July 2012).
- [7] Global Wind Energy Council. GWEC: GlobalWind Statistics 2011. <http://www.gwec.net/> (accessed 4 July 2012).
- [8] Mur, J. Curso de energía eólica. España. Departamento de Ingeniería Eléctrica de la Universidad de Zaragoza. <http://www.joaquinmur.eu/manualEolico.pdf> (accessed 16 June 2012)
- [9] WRPLOT View program Version 5.9 by Lakes Environmental. Canada. © 1998-2008.
- [10] Wind Atlas Analysis and Application Program (WAsP®) by Risø National Laboratory, Technical University of Denmark (DTU), Roskilde, Denmark. © 1987-2007.
- [11] Medina, G., Reporte Agrometereológico August 2005 - July 2006, INIFAP Centro de Investigación Regional Norte Centro, Campo Experimental Zacatecas. Boletines informativos No. 15-26. México.
- [12] Instituto de Investigaciones Eléctricas. IIE. Información anemométrica de la Estación Cieneguillas, Zacatecas. 2005-2006. <http://planeolico.iie.org.mx>. (accessed 24 March 2008).
- [13] Ackerman T., editor. Wind Power in Power Systems. 2nd Ed. USA: John Wiley and Sons; 2005.
- [14] Wildi T. Electrical Machines. Drives and Power Systems 6th Ed. USA: Prentice Hall; 2006.
- [15] Comisión Federal de Electricidad CFE. Estadísticas. <http://app.cfe.gob.mx/ Aplicaciones/QCFE/EstVtas/Default.aspx>. (accessed 12 July 2012)
- [16] Reta-Hernandez M, Soto CE, De la Torre J, Ibarra S, Álvarez JA, Romo-Guzmán G, Bañuelos- Ruedas F, Ochoa Ortiz CA, Martínez, AE, Medina G. and Rumayor A F. Resultados preliminares de la evaluación del recurso eólico en varios sitios del Estado de Zacatecas. Presented in XXXI Semana nacional de energía solar. Zacatecas, México. October 2007.
- [17] Ángeles-Camacho C, Bañuelos-Ruedas F. and Badillo-Fuentes JF. El recurso eólico en el Estado de Zacatecas: Características del viento en 36 localidades. México: II-UN-AM; 2011.

- [18] Comisión Federal de Electricidad. CFE: Costos de generación por tecnología. http://www.cfe.gob.mx/QuienesSomos/queEsCFE/Documents/2012/Administracion/Costo-degeneracionportecnologia2002_2011.pdf. (accessed 12 July 2012).
- [19] Sovacool BK. Valuing the greenhouse gas emissions from nuclear power: A critical survey. *Energy Policy*. 2008; 36(8) 2940-2953.
- [20] Merino L. Energías renovables. (Colec. Energías renovables para todos). España. Haya Comunicación. http://www.energiasrenovables.com/Productos/pdf/cuaderno_GENERAL.pdf (accessed 18 June 2012).
- [21] Spadaro V, Langlois L and Hamilton B. Greenhouse gas emissions of electricity generation chains: assessing the difference. *IAEA. Bull* 2000; 42(2) 19-24.

